

MOBILYA KATALOG RAY VE KAPAK PROFİLLERİ

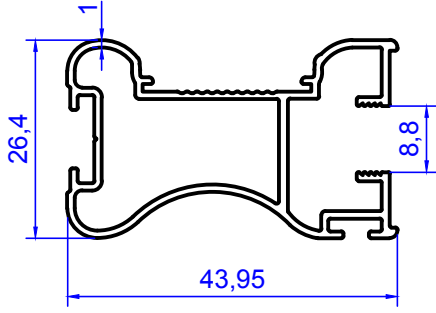

2000
0.491 kg/m

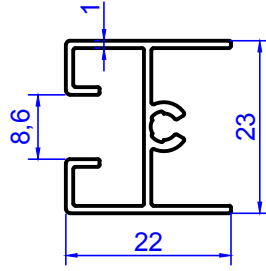

2001
0.263 kg/m

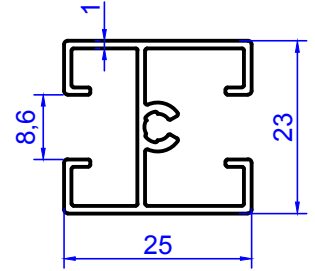

2002
0.317 kg/m

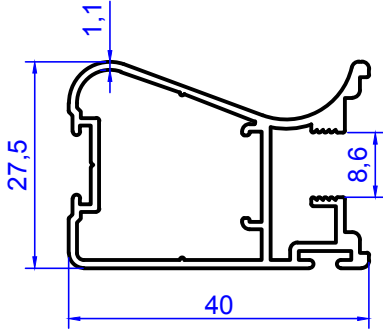

2003
0.518 kg/m

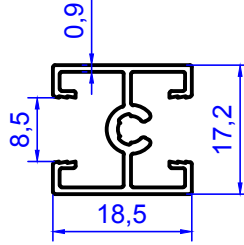

2004
0.217 kg/m

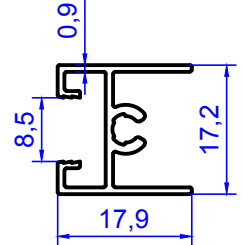

2005
0.187 kg/m

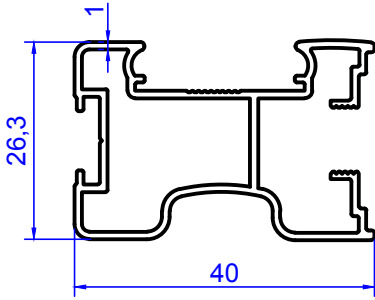

2006
0.467 kg/m

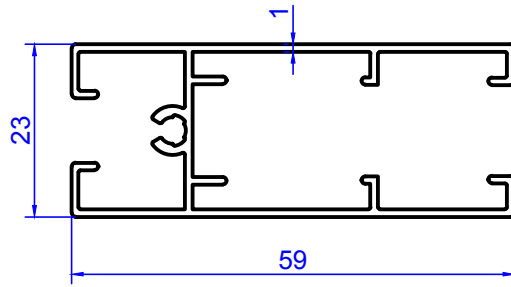

2007
0.545 kg/m

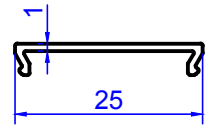

2008
0.087 kg/m

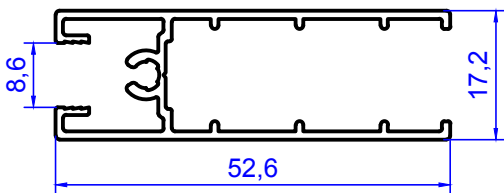

2009
0.455 kg/m

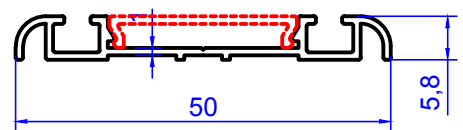

2010
0.230 kg/m

MOBILYA KATALOG RAY VE KAPAK PROFİLLERİ

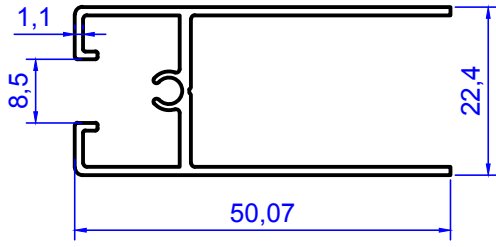

2011
0.441 kg/m

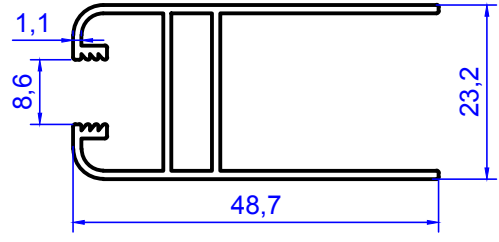

2012
0.473 kg/m

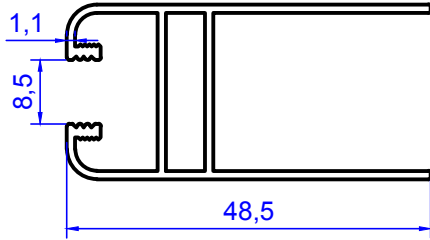

2013
0.476 kg/m

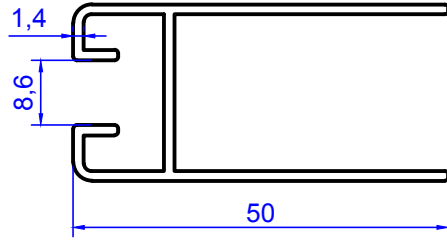

2014
0.506 kg/m

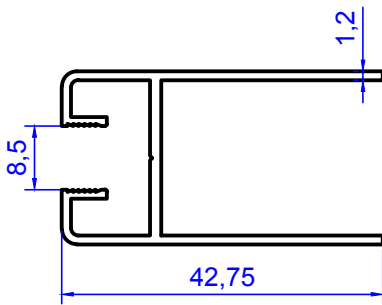

2015
0.425 kg/m

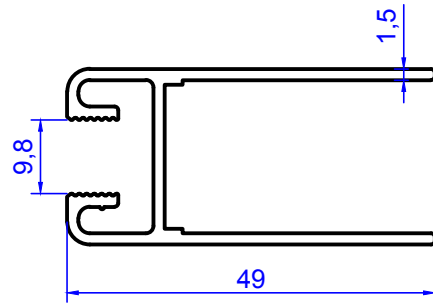

2016
0.575 kg/m

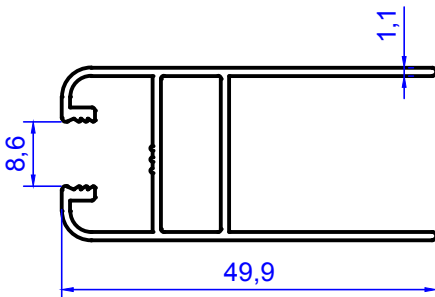

2017
0.480 kg/m

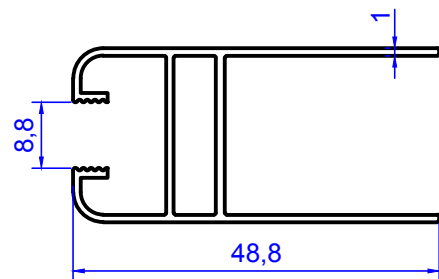

2018
0.436 kg/m

MOBİLYA KATALOG RAY VE KAPAK PROFİLLERİ

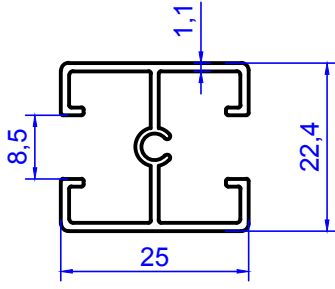

2019
0.307 kg/m

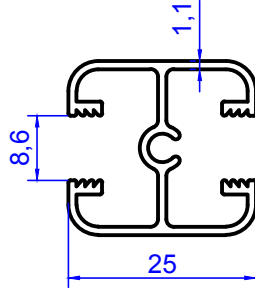

2020
0.351 kg/m

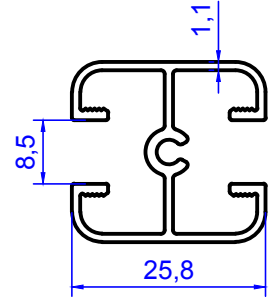

2021
0.370 kg/m

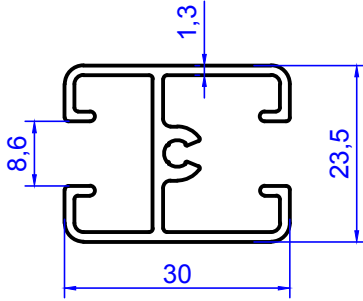

2022
0.455 kg/m

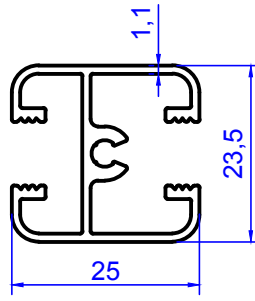

2023
0.384 kg/m

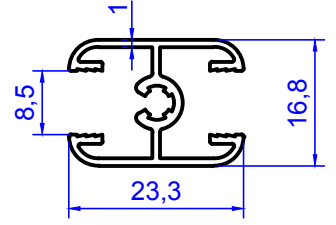

2024
0.260 kg/m

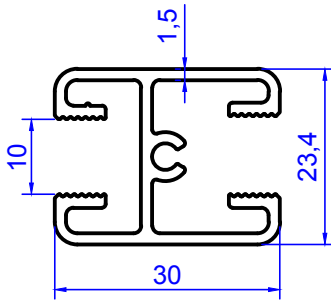

2025
0.531 kg/m

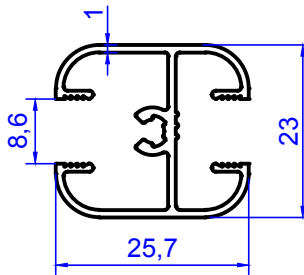

2026
0.317 kg/m

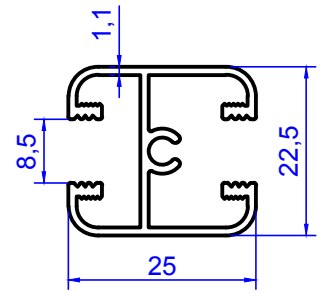

2027
0.358 kg/m

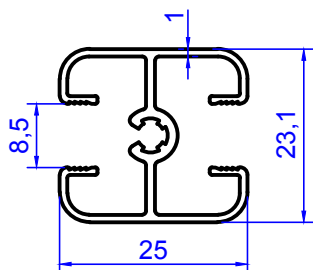

2028
0.328 kg/m

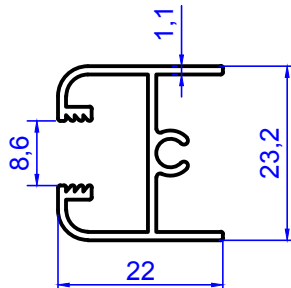

2029
0.280 kg/m

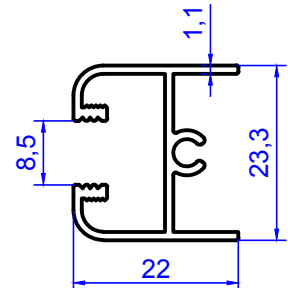

2030
0.285 kg/m

MOBILYA KATALOG RAY VE KAPAK PROFİLLERİ

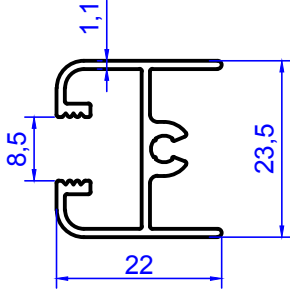

2031
0.305 kg/m

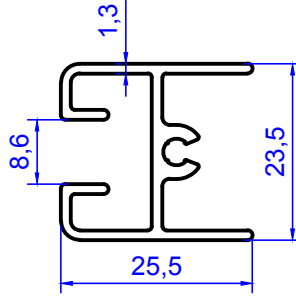

2032
0.382 kg/m

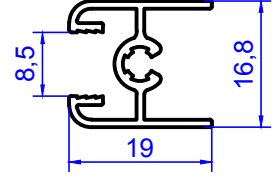

2033
0.211 kg/m

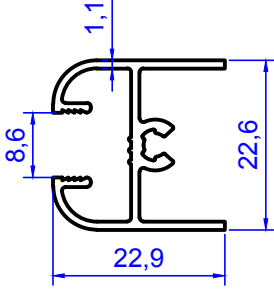

2034
0.287 kg/m

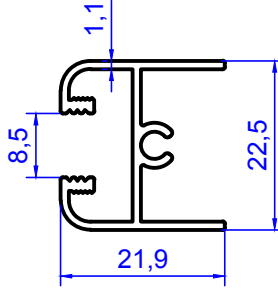

2035
0.279 kg/m

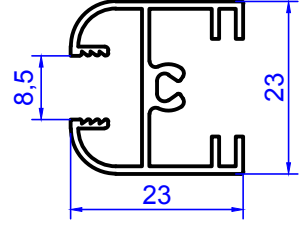

2036
0.312 kg/m

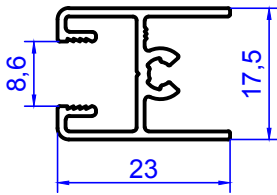

2037
0.266 kg/m

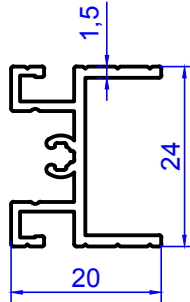

2038
0.312 kg/m

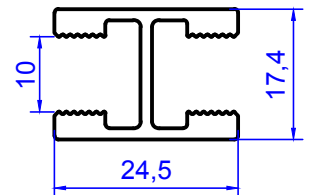

2039
0.412 kg/m

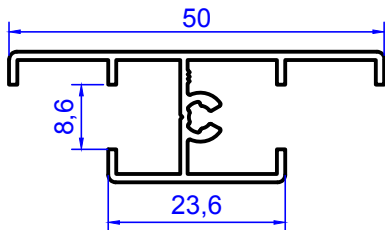

2040
0.355 kg/m

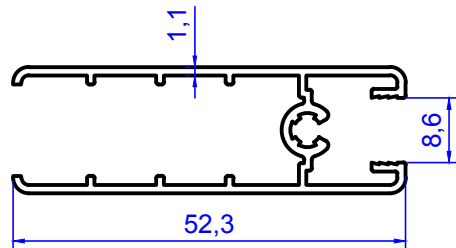

2041
0.447 kg/m

MOBILYA KATALOG
RAY VE KAPAK PROFİLLERİ

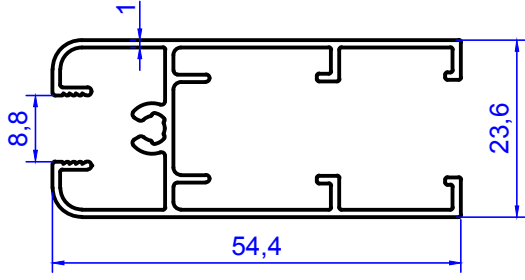

2042
0.545 kg/m

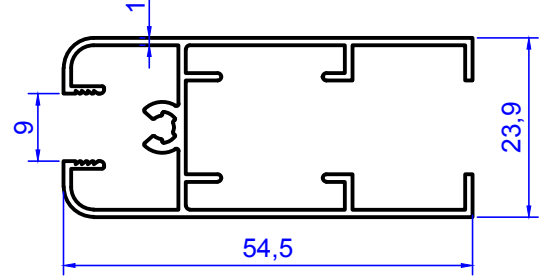

2043
0.537 kg/m

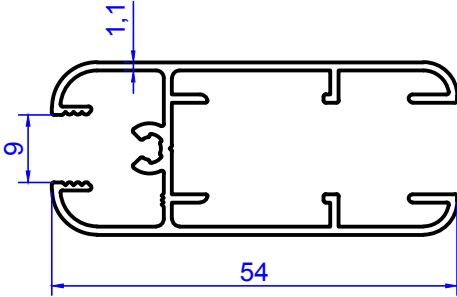

2044
0.572 kg/m

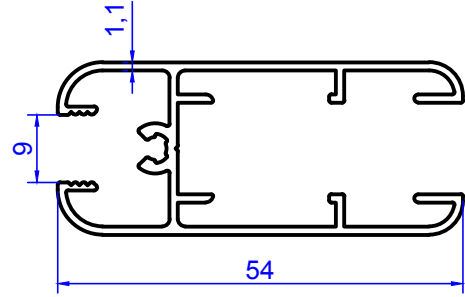

2045
0.572 kg/m

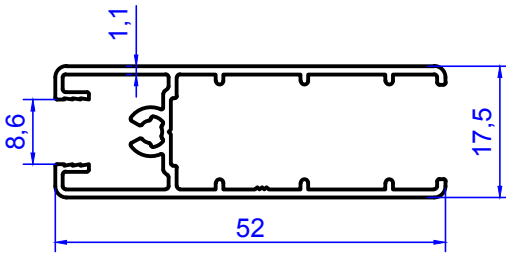

2046
0.439 kg/m

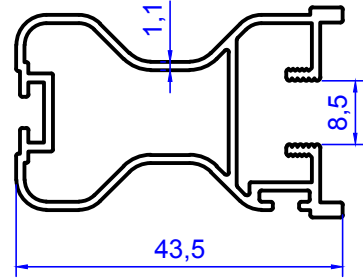

2047
0.554 kg/m

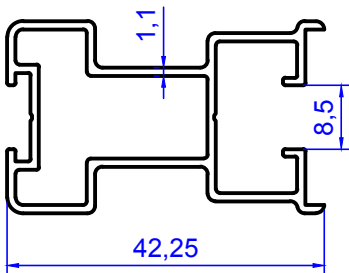

2048
0.496 kg/m

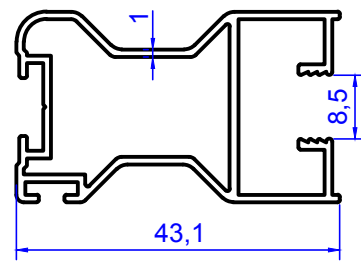

2049
0.501 kg/m

MOBILYA KATALOG RAY VE KAPAK PROFİLLERİ

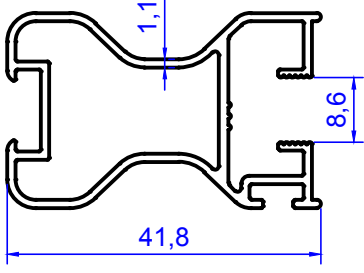

2050
0.520 kg/m

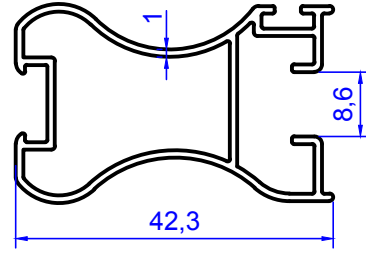

2051
0.453 kg/m

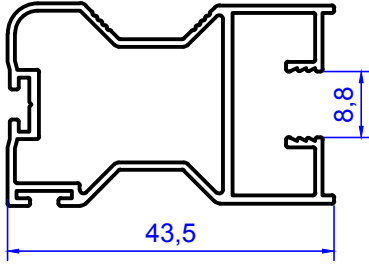

2052
0.523 kg/m

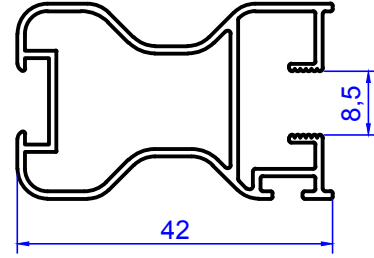

2053
0.499 kg/m

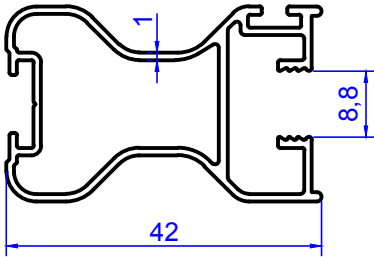

2054
0.485 kg/m

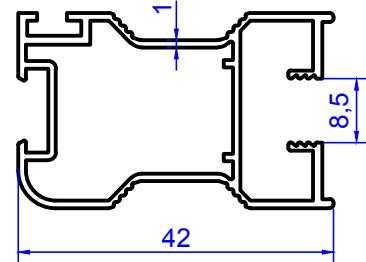

2055
0.477 kg/m

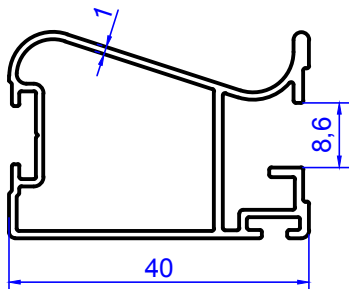

2056
0.472 kg/m

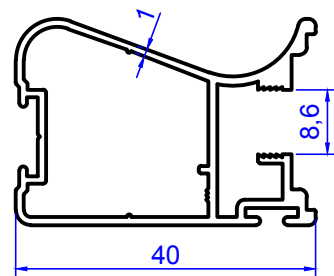

2057
0.504 kg/m

MOBILYA KATALOG RAY VE KAPAK PROFİLLERİ

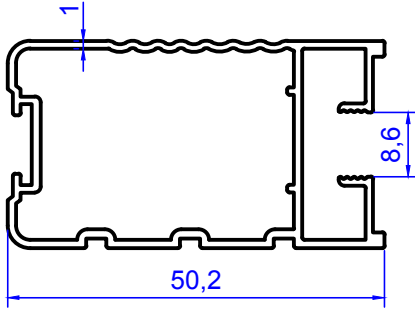

2058
0.558 kg/m

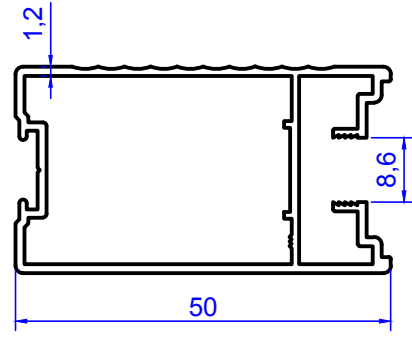

2059
0.575 kg/m

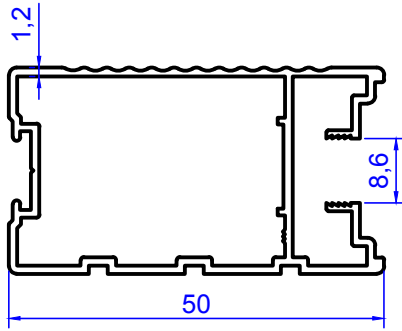

2060
0.558 kg/m

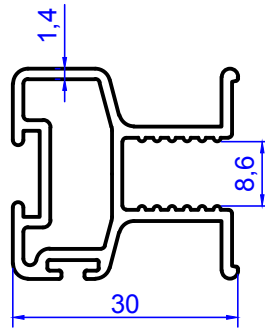

2061
0.546 kg/m

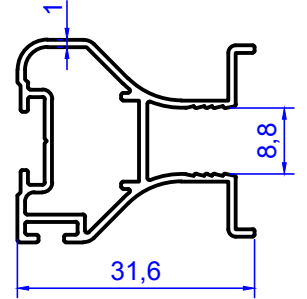

2062
0.377 kg/m

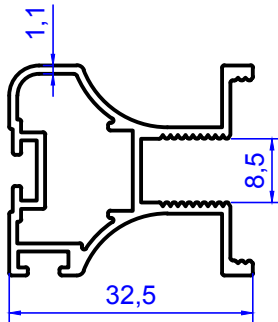

2063
0.469 kg/m

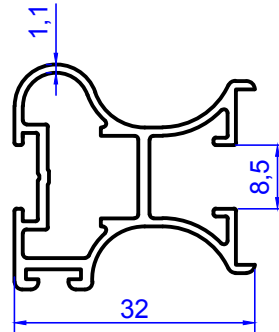

2064
0.487 kg/m

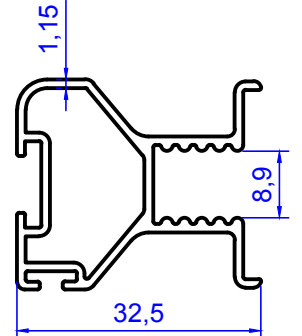

2065
0.458 kg/m

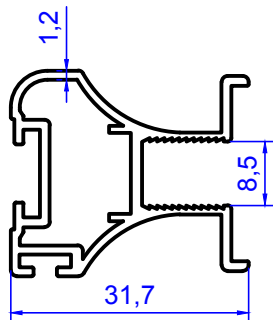

2066
0.469 kg/m

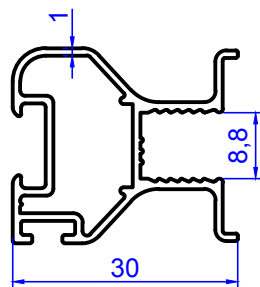

2067
0.379 kg/m

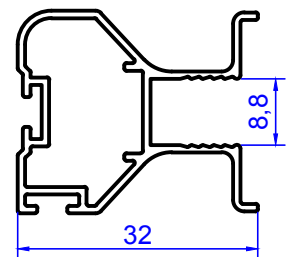

2068
0.371 kg/m

MOBİLYA KATALOG RAY VE KAPAK PROFİLLERİ

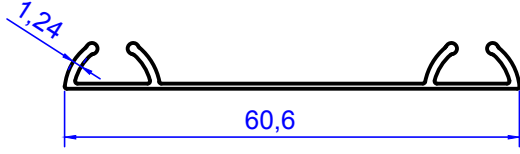

2069
0.200 kg/m

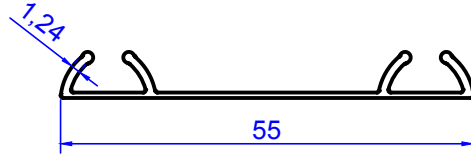

2070
0.190 kg/m

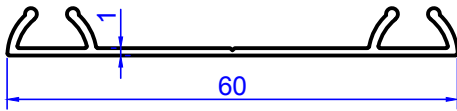

2071
0.244 kg/m

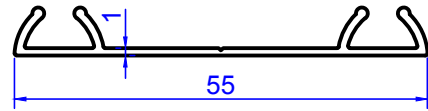

2072
0.230 kg/m

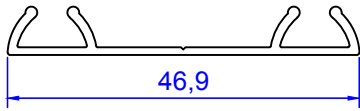

2073
0.209 kg/m

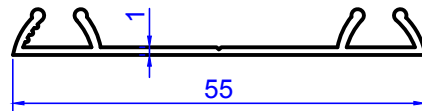

2074
0.228 kg/m

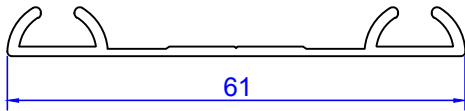

2075
0.301 kg/m

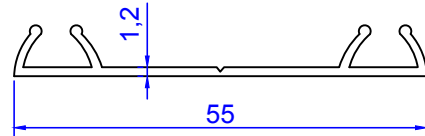

2076
0.257 kg/m

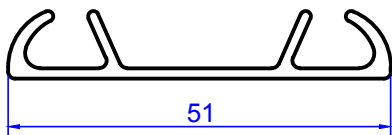

2077
0.349 kg/m

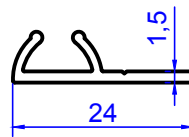

2078
0.138 kg/m

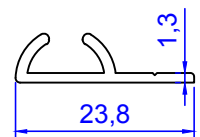

2079
0.133 kg/m

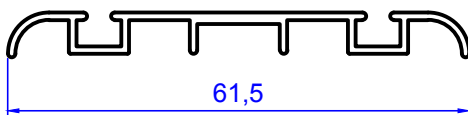

2080
0.282 kg/m

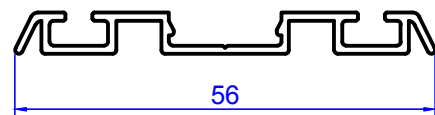

2081
0.284 kg/m

MOBILYA KATALOG RAY VE KAPAK PROFİLLERİ

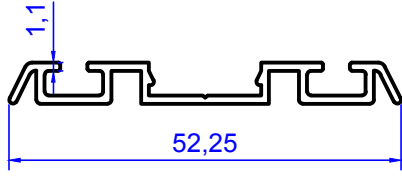

2082
0.274 kg/m

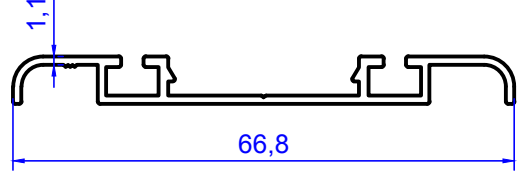

2083
0.325 kg/m

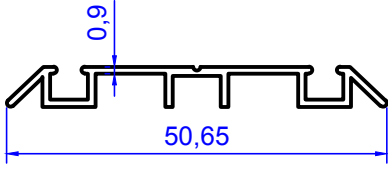

2084
0.222 kg/m

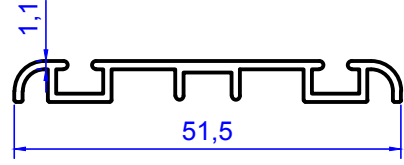

2085
0.271 kg/m

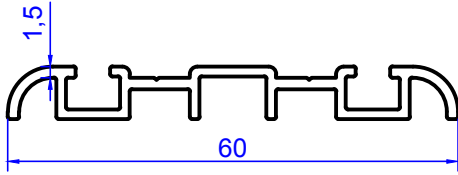

2086
0.391 kg/m

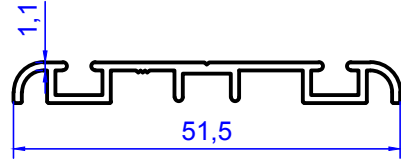

2087
0.271 kg/m

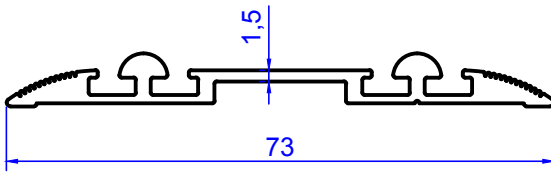

2088
0.509 kg/m

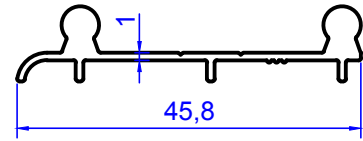

2089
0.293 kg/m

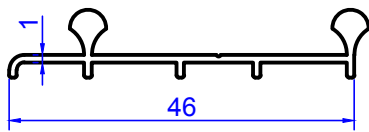

2090
0.241 kg/m

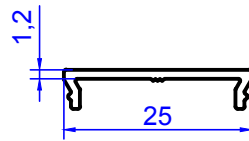

2091
0.111 kg/m

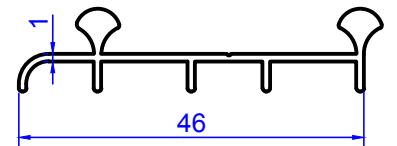

2092
0.276 kg/m

MOBILYA KATALOG RAY VE KAPAK PROFİLLERİ

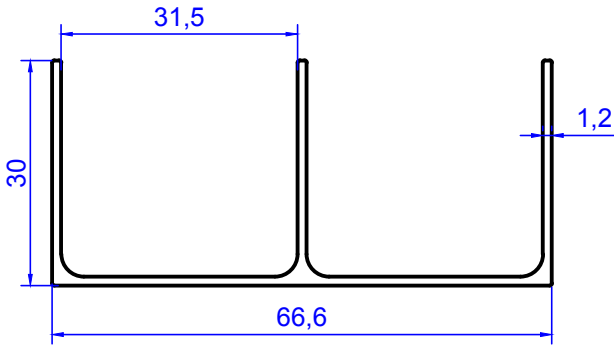

2093
0.518 kg/m

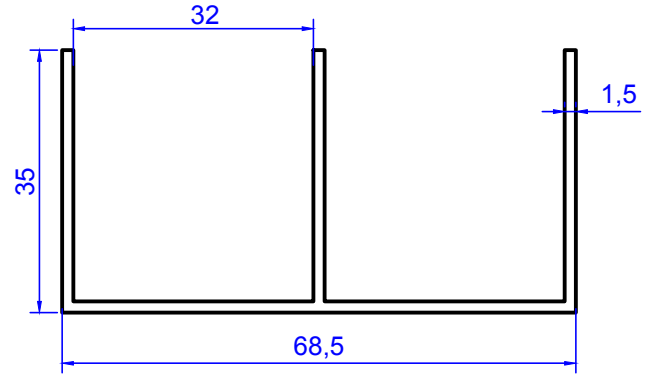

2094
0.686 kg/m

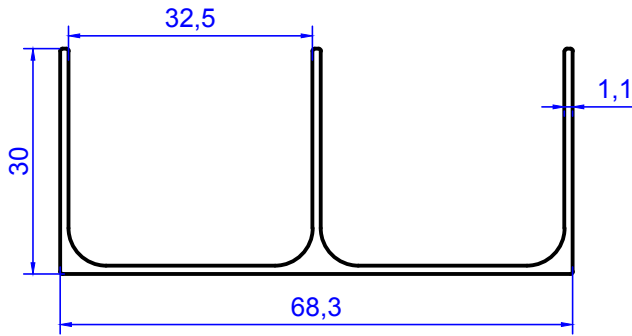

2095
0.520 kg/m

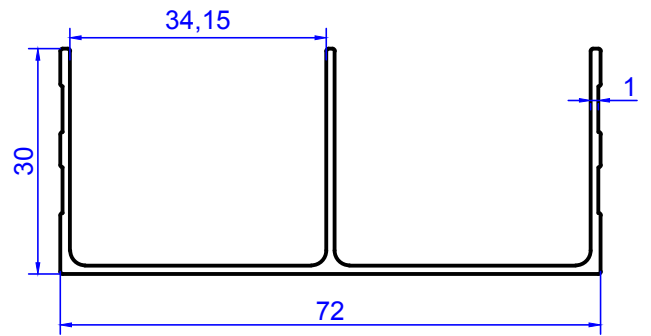

2096
0.493 kg/m

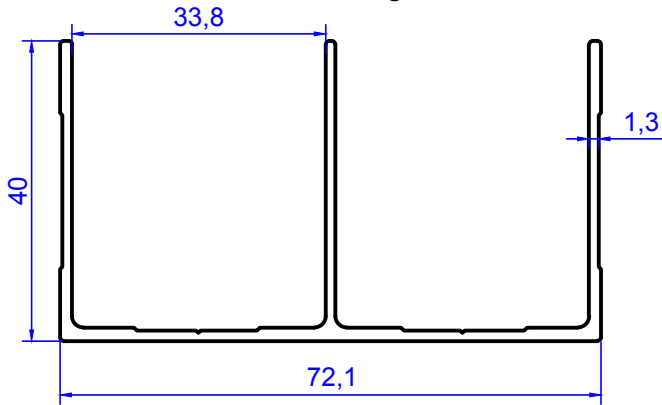

2097
0.752 kg/m

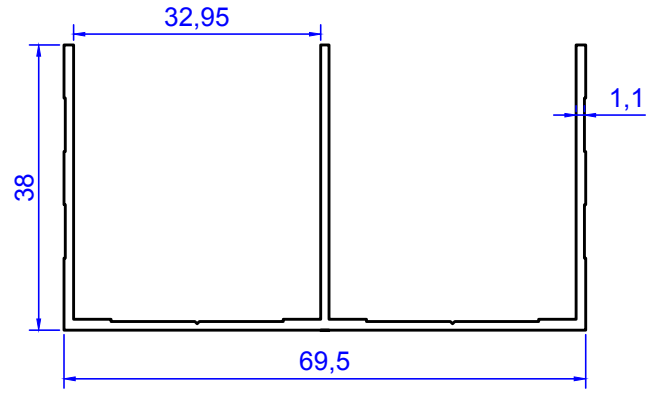

2098
0.580 kg/m

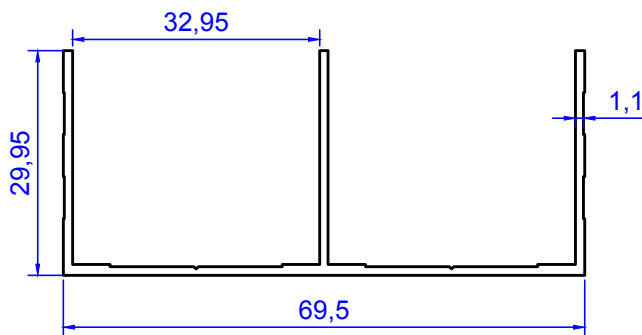

2099
0.504 kg/m

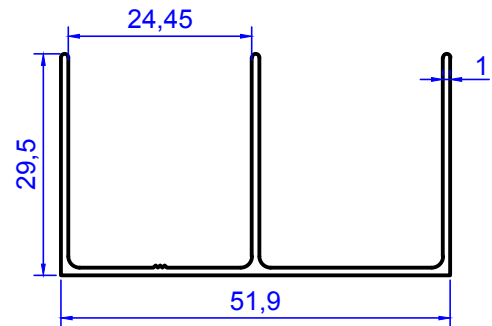

2100
0.377 kg/m

MOBILYA KATALOG RAY VE KAPAK PROFİLLERİ

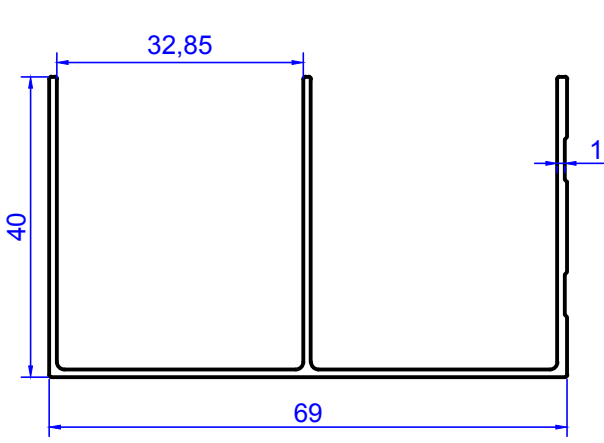

2101
0.752 kg/m

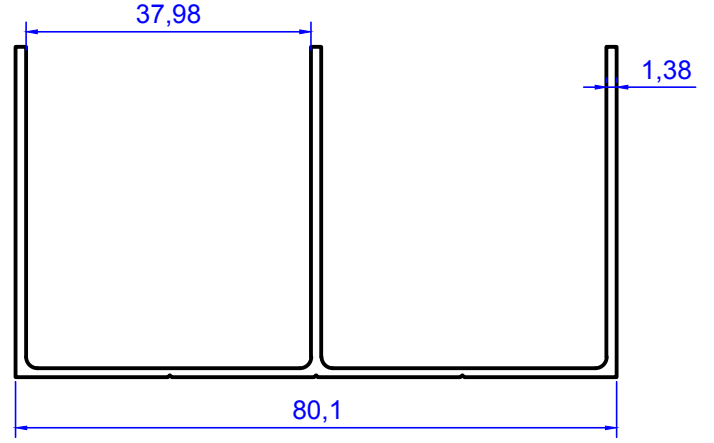

2102
0.745 kg/m

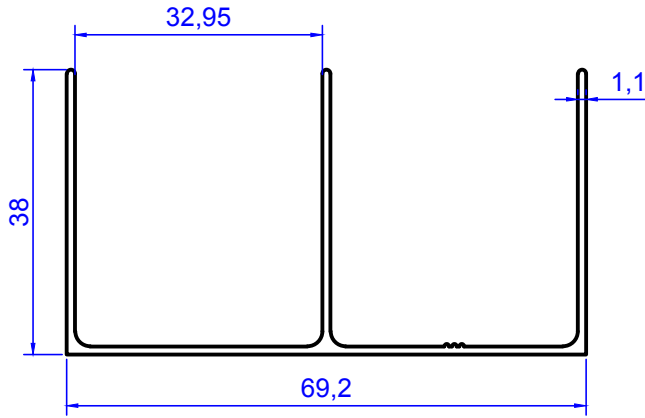

2103
0.545 kg/m

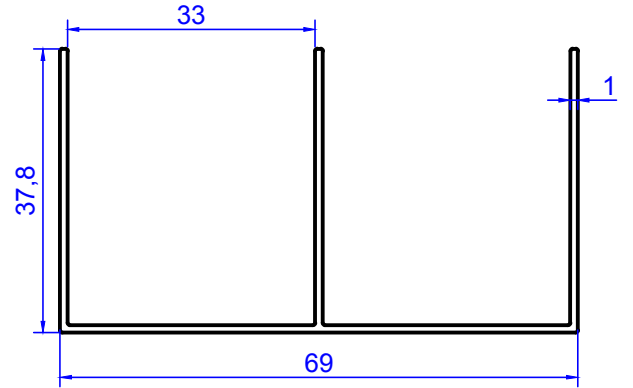

2104
0.545 kg/m

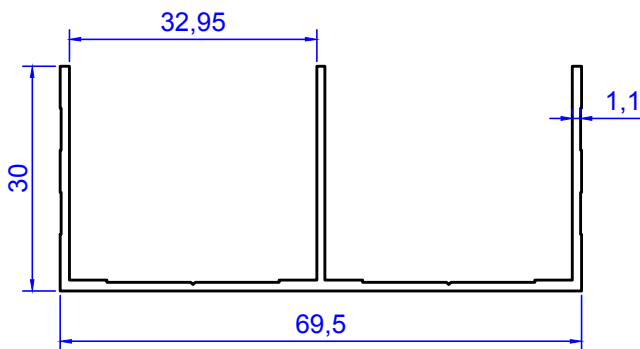

2105
0.537 kg/m

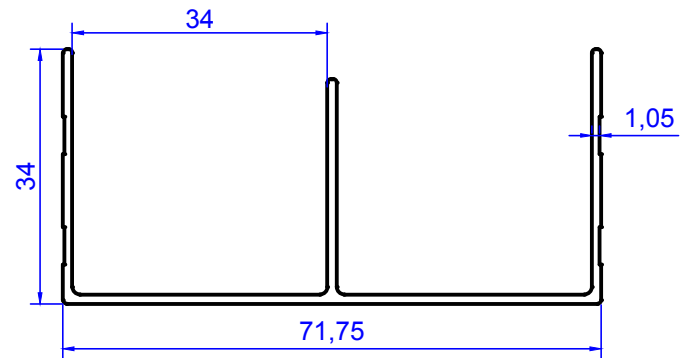

2106
0.553 kg/m

MOBILYA KATALOG

RAY VE KAPAK PROFİLLERİ

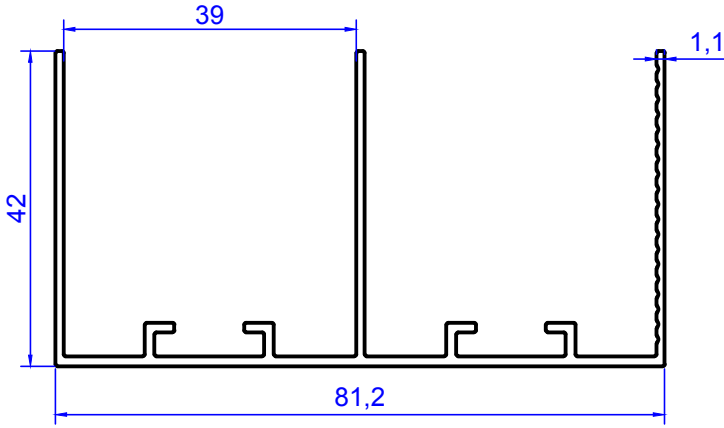

2107
0.743 kg/m

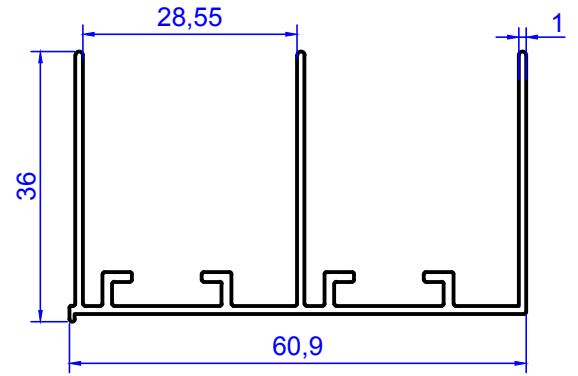

2108
0.558 kg/m

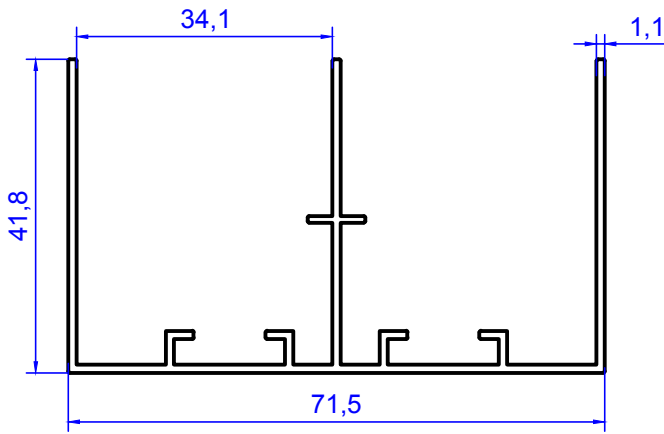

2109
0.678 kg/m

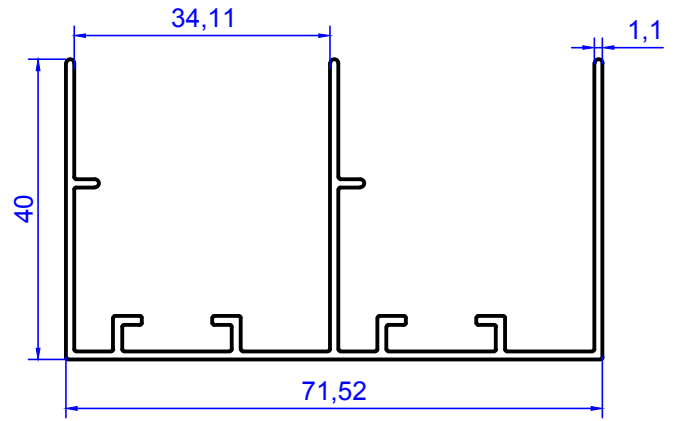

2110
0.678 kg/m

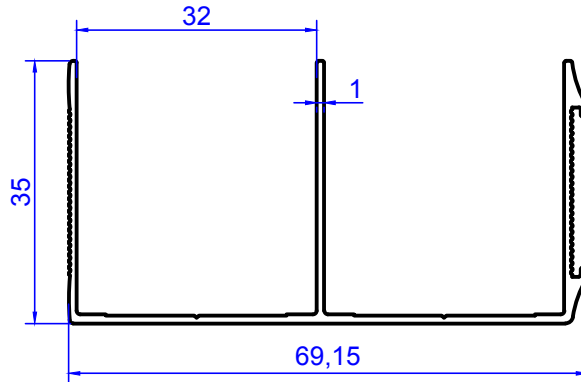

2111
0.499 kg/m

MOBILYA KATALOG RAY VE KAPAK PROFİLLERİ

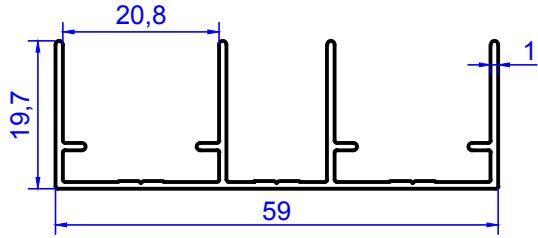

2112
0.382 kg/m

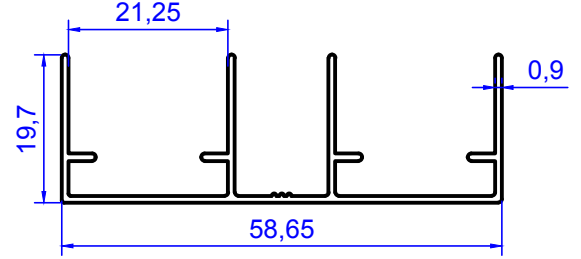

2113
0.366 kg/m

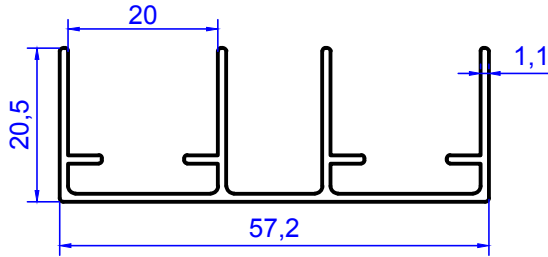

2114
0.458 kg/m

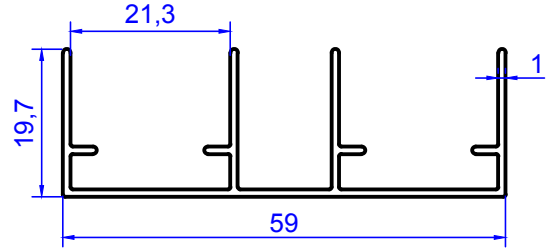

2115
0.398 kg/m

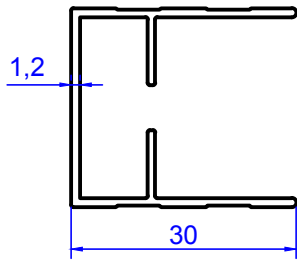

2116
0.309 kg/m

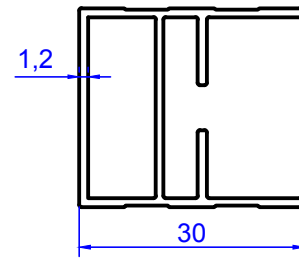

2117
0.385 kg/m

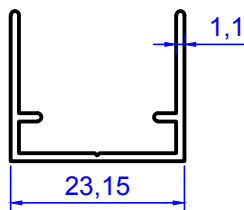

2118
0.198 kg/m

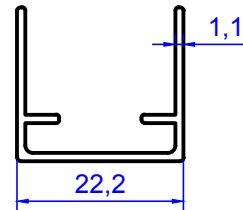

2119
0.209 kg/m

MOBILYA KATALOG CEKME KULP PROFLLERI

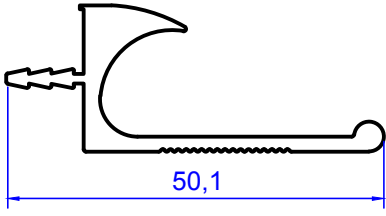

2120
0.544 kg/m

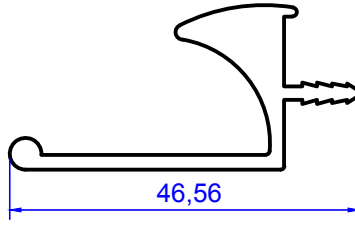

2121
0.609 kg/m

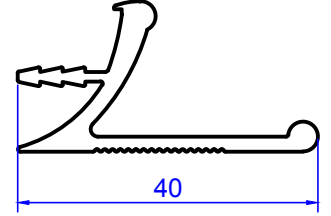

2122
0.446 kg/m

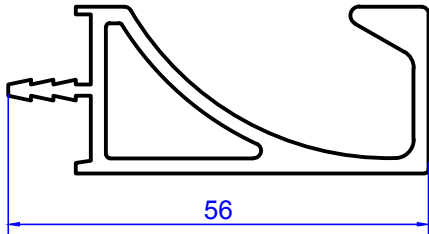

2123
0.848 kg/m

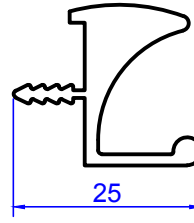

2124
0.429 kg/m

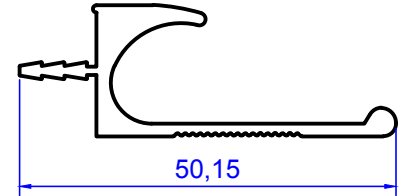

2125
0.456 kg/m

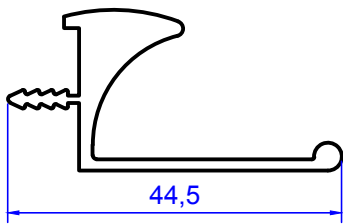

2126
0.519 kg/m

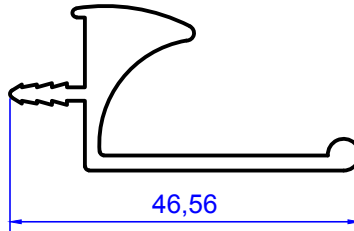

2127
0.609 kg/m

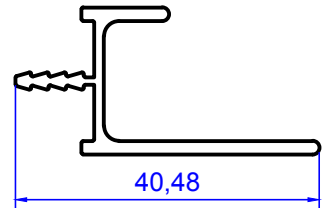

2128
0.318 kg/m

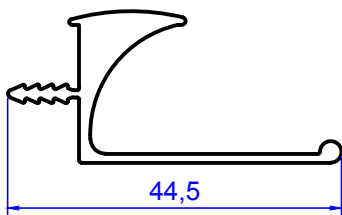

2129
0.417 kg/m

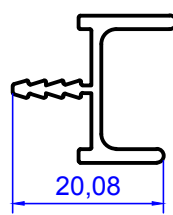

2130
0.225 kg/m

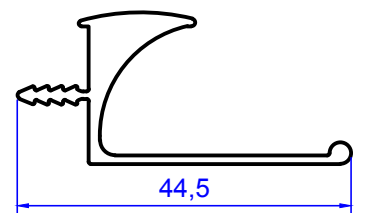

2131
0.417 kg/m

MOBILYA KATALOG

RAY KAPAK KULP PROFILLERİ

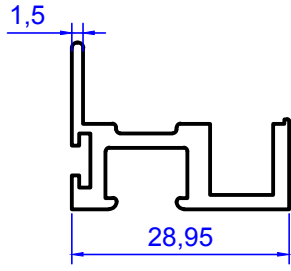

2132
0.423 kg/m

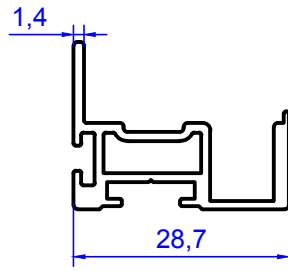

2133
0.360 kg/m

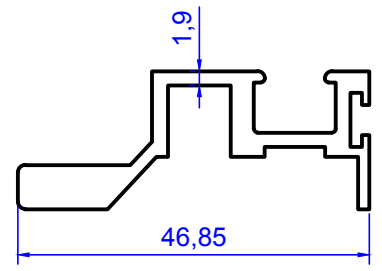

2134
0.653 kg/m

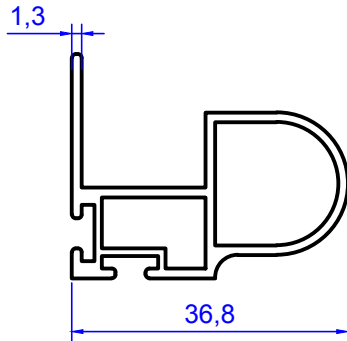

2135
0.493 kg/m

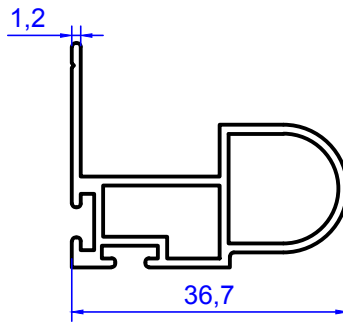

2136
0.455 kg/m

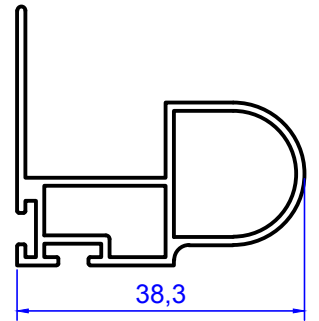

2137
0.452 kg/m

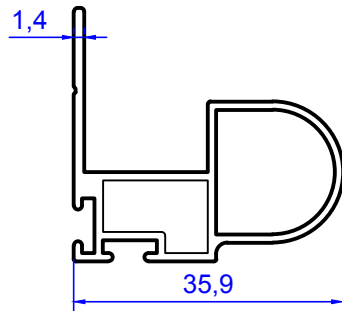

2138
0.453 kg/m

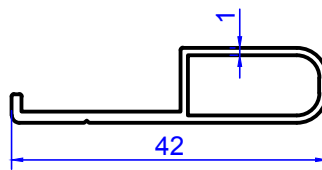

2139
0.238 kg/m

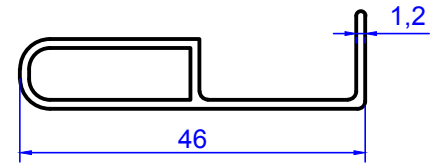

2140
0.302 kg/m

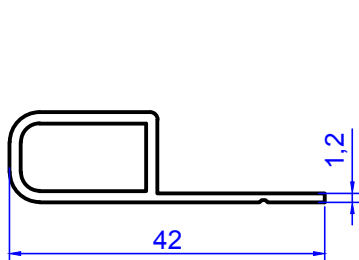

2141
0.293 kg/m

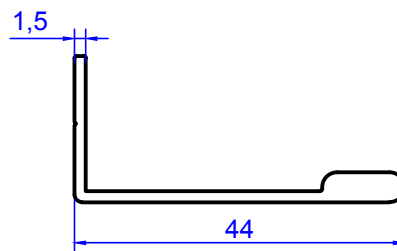

2142
0.319 kg/m

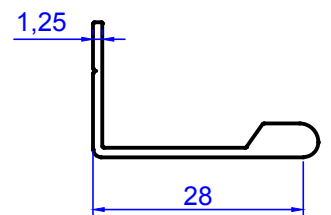

2143
0.225 kg/m

MOBILYA KATALOG

RAY KAPAK KULP PROFILLERİ

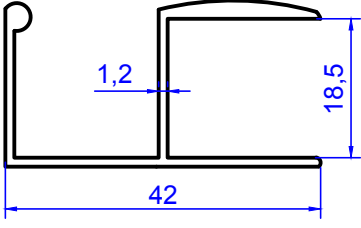

2144
0.393 kg/m

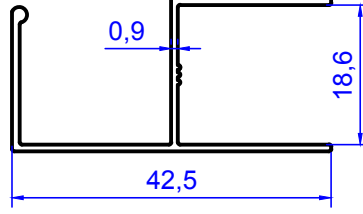

2145
0.304 kg/m

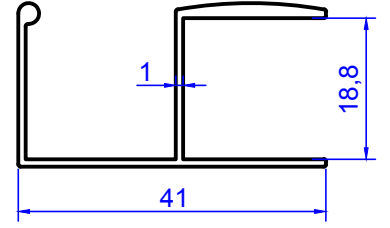

2146
0.320 kg/m

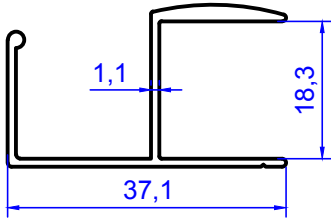

2147
0.306 kg/m

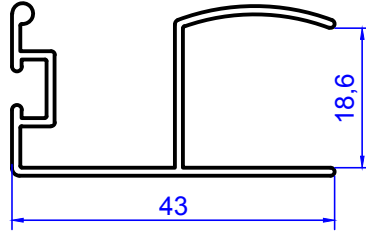

2148
0.360 kg/m

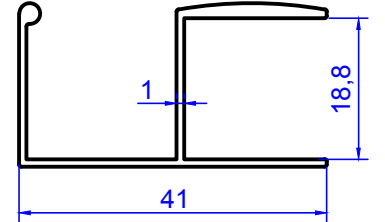

2149
0.363 kg/m

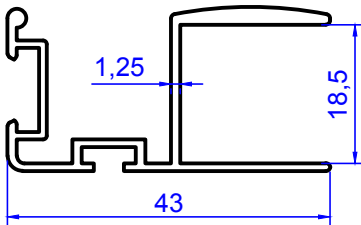

2150
0.420 kg/m

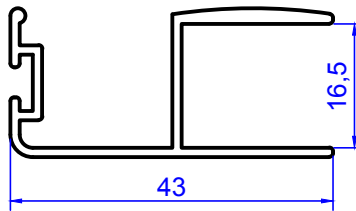

2151
0.398 kg/m

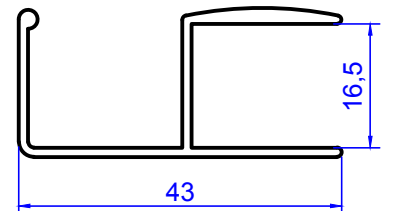

2152
0.366 kg/m

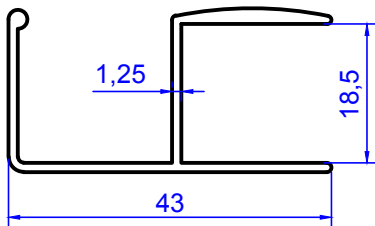

2153
0.379 kg/m

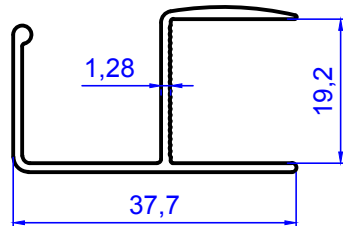

2154
0.309 kg/m

MOBILYA KATALOG

RAY KAPAK KULP PROFİLLERİ

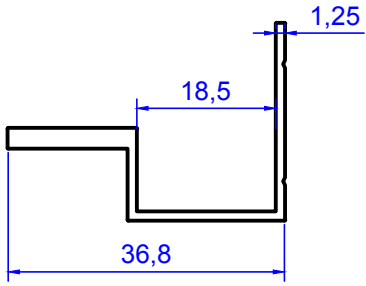

2155
0.268 kg/m

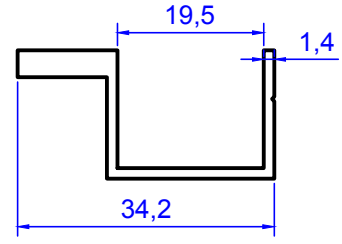

2156
0.325 kg/m

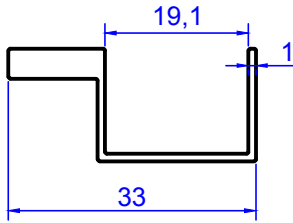

2157
0.263 kg/m

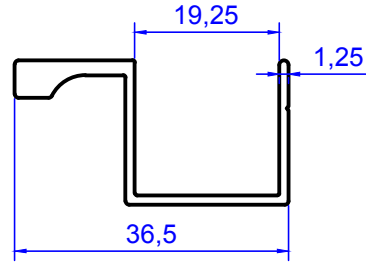

2158
0.325 kg/m

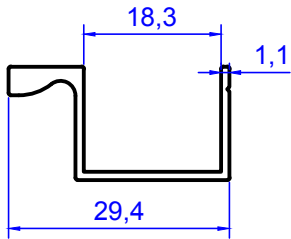

2159
0.217 kg/m

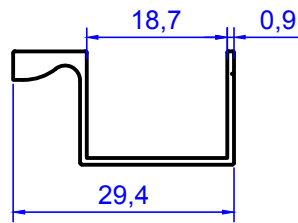

2160
0.190 kg/m

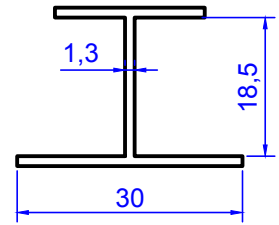

2161
0.241 kg/m

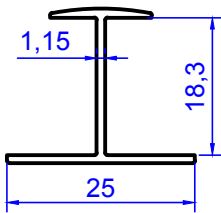

2162
0.168 kg/m

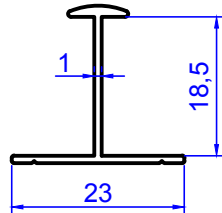

2163
0.136 kg/m

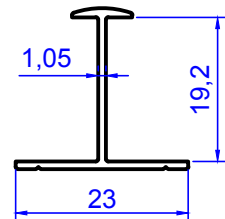

2164
0.141 kg/m

MOBILYA KATALOG SUNTA KENAR PROFİLLERİ

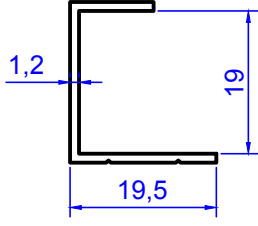

2165
0.160 kg/m

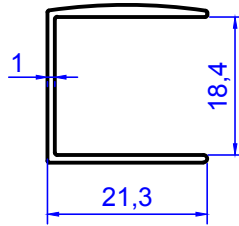

2166
0.190 kg/m

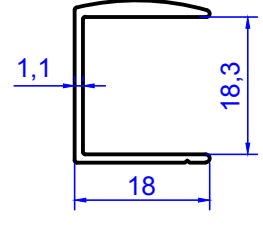

2167
0.195 kg/m

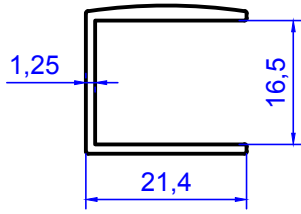

2168
0.228 kg/m

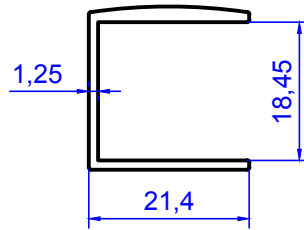

2169
0.238 kg/m

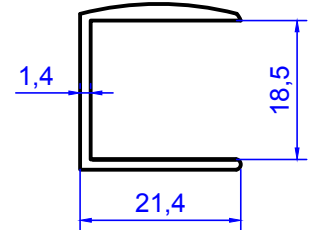

2170
0.252 kg/m

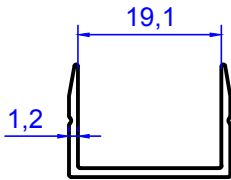

2171
0.149 kg/m

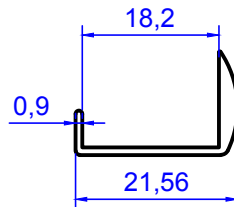

2172
0.133 kg/m

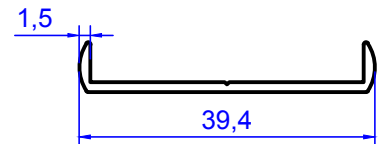

2173
0.171 kg/m

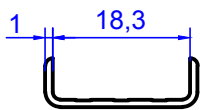

2174
0.078 kg/m

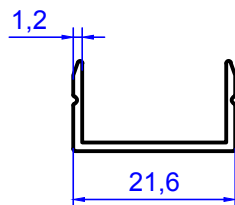

2175
0.130 kg/m

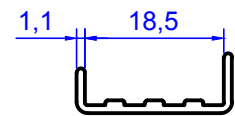

2176
0.106 kg/m

MOBILYA KATALOG SUNTA KENAR PROFILLERİ

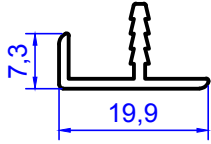

2177
0.141 kg/m

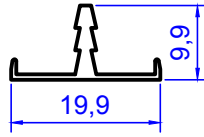

2178
0.097 kg/m

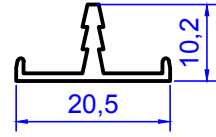

2179
0.119 kg/m

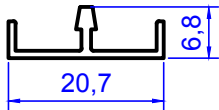

2180
0.101 kg/m

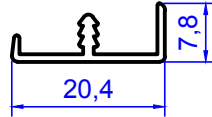

2181
0.106 kg/m

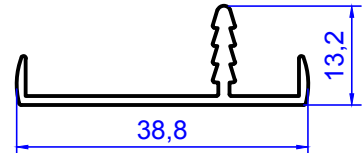

2182
0.225 kg/m

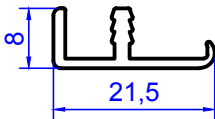

2183
0.149 kg/m

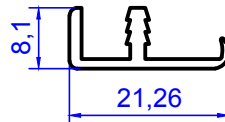

2184
0.150 kg/m

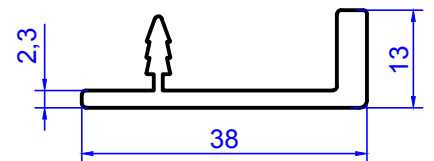

2185
0.409 kg/m

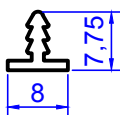

2186
0.065 kg/m

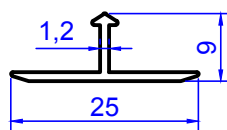

2187
0.106 kg/m

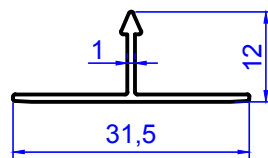

2188
0.119 kg/m

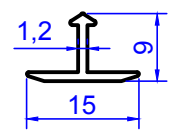

2189
0.073 kg/m

MOBILYA KATALOG GÖMME RAY PROFİLLERİ

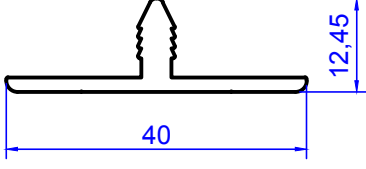

2190
0.320 kg/m

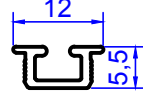

2191
0.070 kg/m

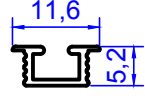

2192
0.054 kg/m

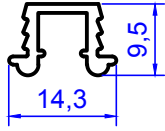

2193
0.128 kg/m

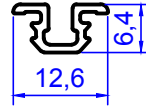

2194
0.073 kg/m

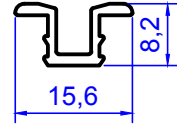

2195
0.102 kg/m

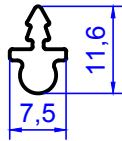

2196
0.111 kg/m

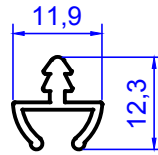

2197
0.117 kg/m

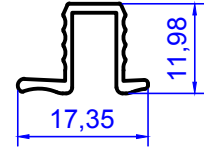

2198
0.119 kg/m

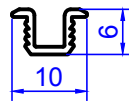

2199
0.051 kg/m

MOBILYA KATALOG

MUTFAK BAZA PROFİLLERİ

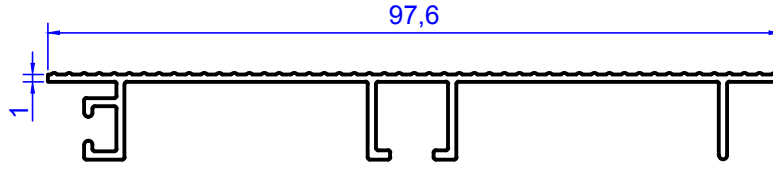

2200
0.450 kg/m

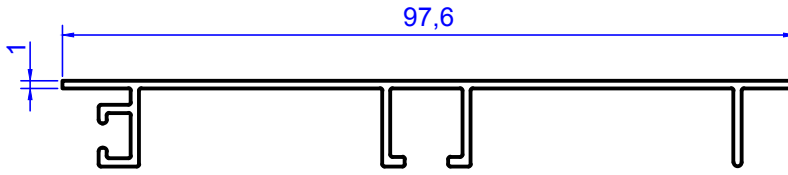

2201
0.434 kg/m

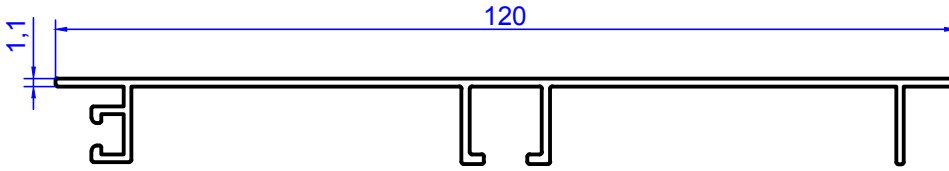

2202
0.518 kg/m

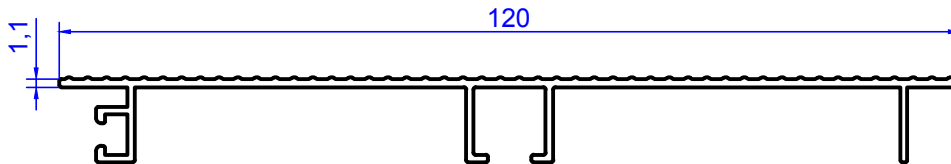

2203
0.523 kg/m

MOBILYA KATALOG
MUTFAK BAZA PROFILLERI

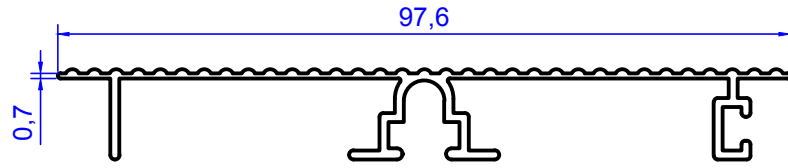

2204
0.472 kg/m

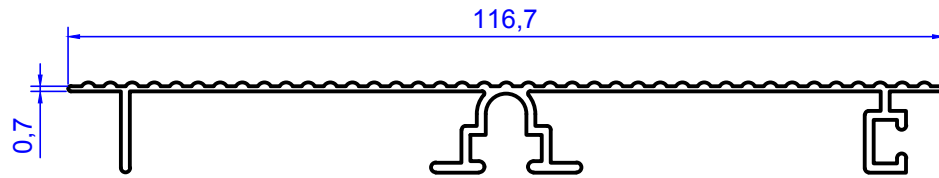

2205
0.520 kg/m

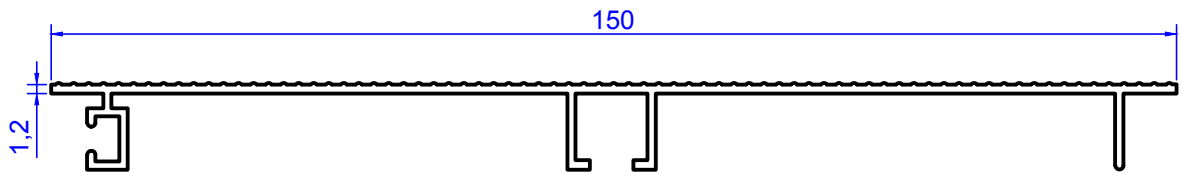

2206
0.678 kg/m

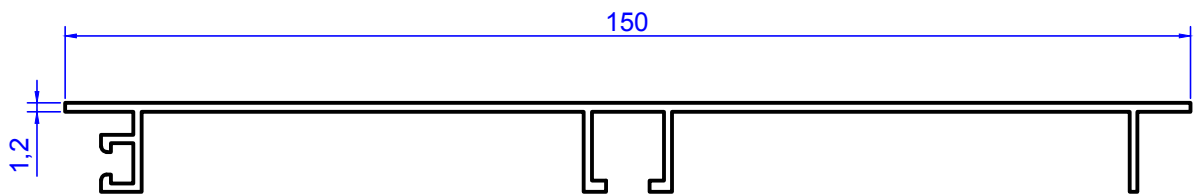

2207
0.661 kg/m

MOBILYA KATALOG
MUTFAK VEMOBILYA DOLAP KAPAK PROFILLERI

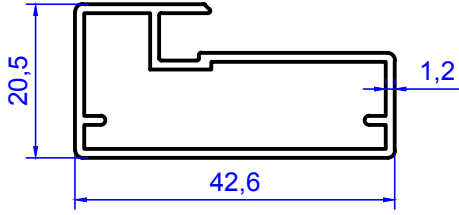

2208
0.439 kg/m

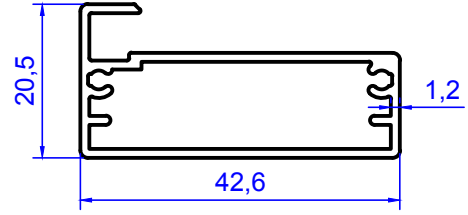

2209
0.447 kg/m

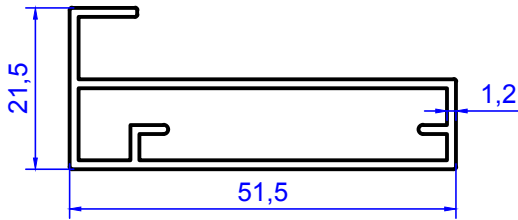

2210
0.493 kg/m

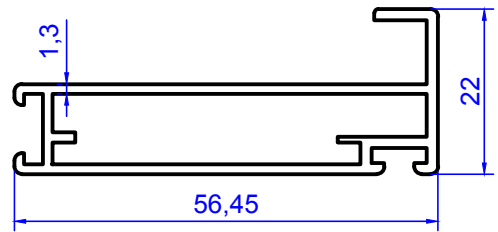

2211
0.594 kg/m

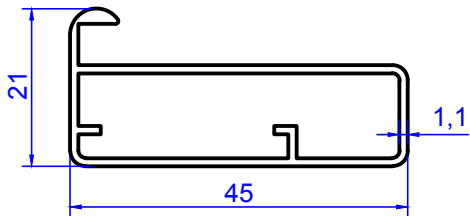

2212
0.398 kg/m

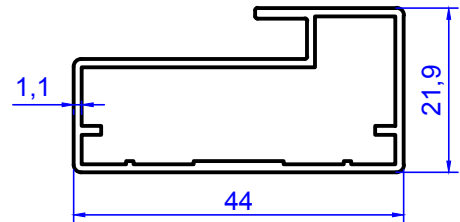

2213
0.436 kg/m

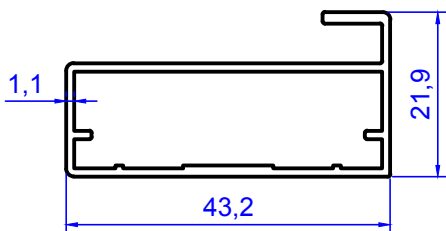

2214
0.414 kg/m

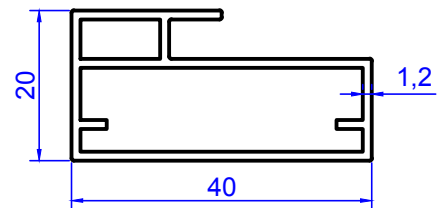

2215
0.454 kg/m

MOBILYA KATALOG
MUTFAK VE MOBILYA DOLAP KAPAK PROFİLLERİ

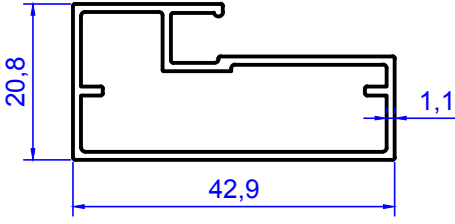

2216
0.416 kg/m

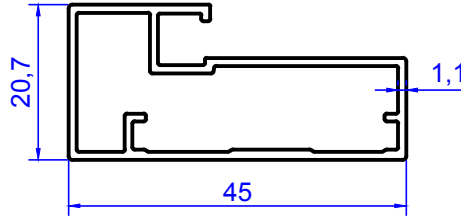

2217
0.444 kg/m

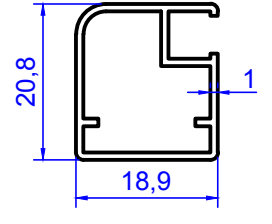

2218
0.230 kg/m

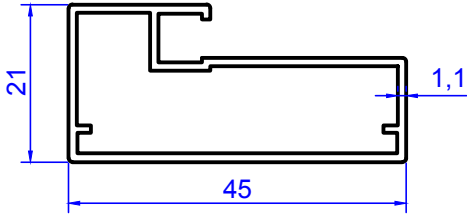

2219
0.431 kg/m

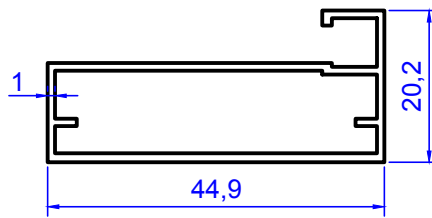

2220
0.388 kg/m

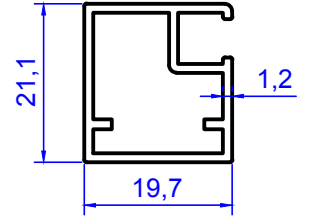

2221
0.295 kg/m

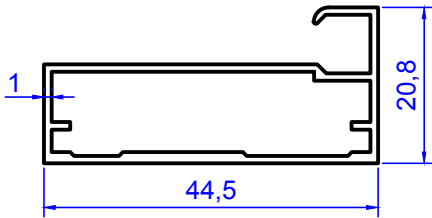

2222
0.390 kg/m

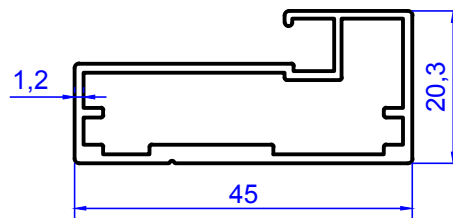

2223
0.520 kg/m

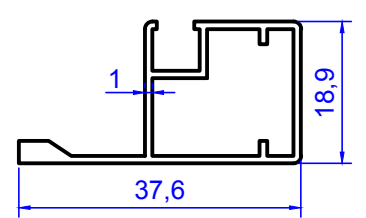

2224
0.309 kg/m

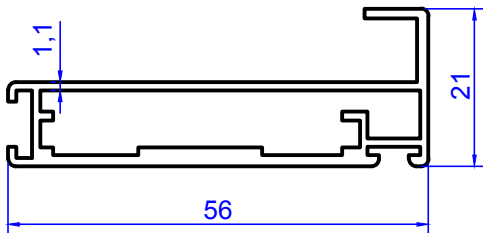

2225
0.602 kg/m

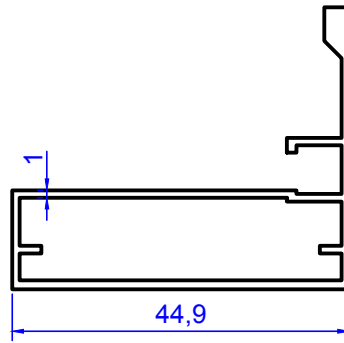

2226
0.469 kg/m

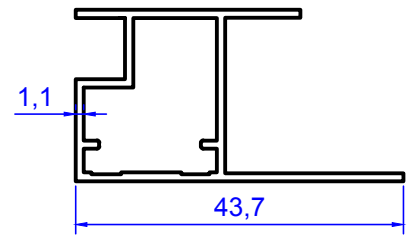

2227
0.369 kg/m

MOBILYA KATALOG

MUTFAK VE MOBILYA DOLAP KAPAK PROFİLLERİ

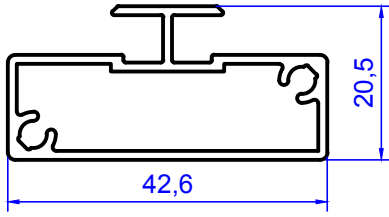

2228
0.481 kg/m

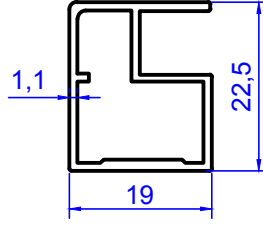

2229
0.276 kg/m

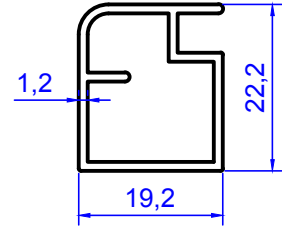

2230
0.285 kg/m

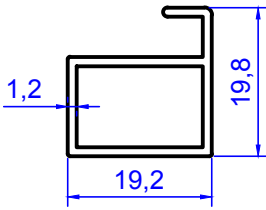

2231
0.233 kg/m

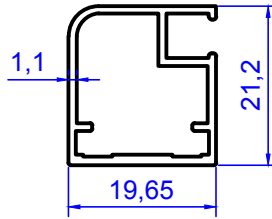

2232
0.263 kg/m

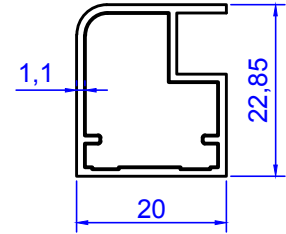

2233
0.268 kg/m

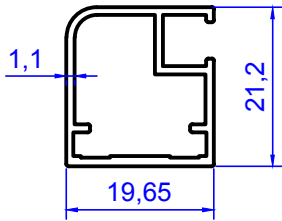

2234
0.265 kg/m

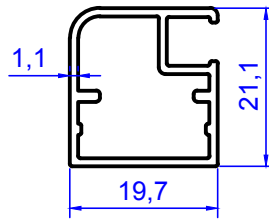

2235
0.274 kg/m

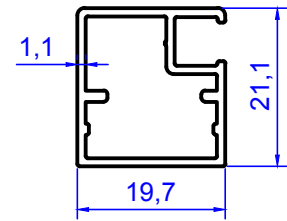

2236
0.278 kg/m

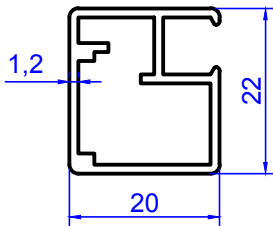

2237
0.317 kg/m

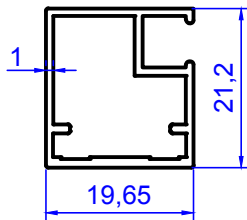

2238
0.263 kg/m

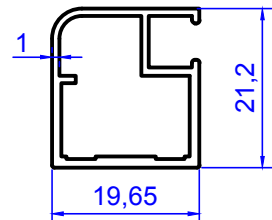

2239
0.268 kg/m

MOBILYA KATALOG
ASKI VE MASA AYAK PROFILLERİ

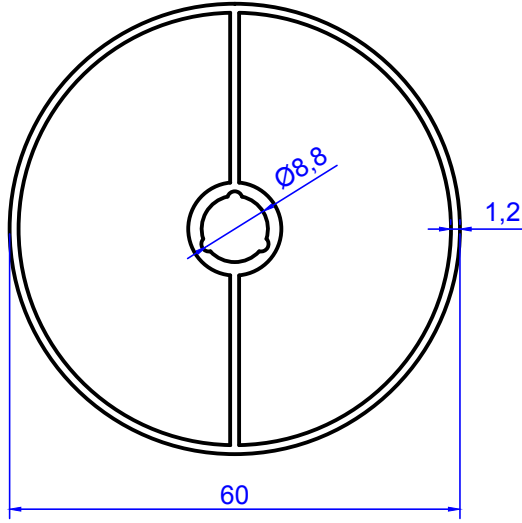

2240
0.902 kg/m

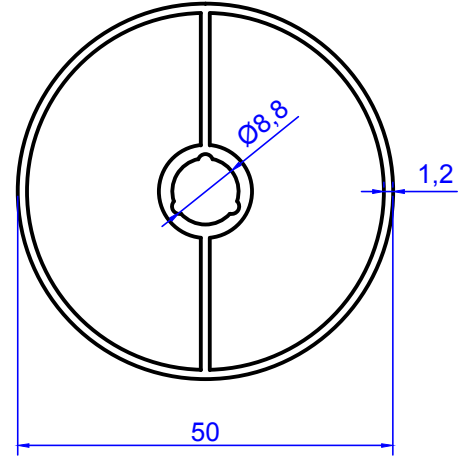

2241
0.770 kg/m

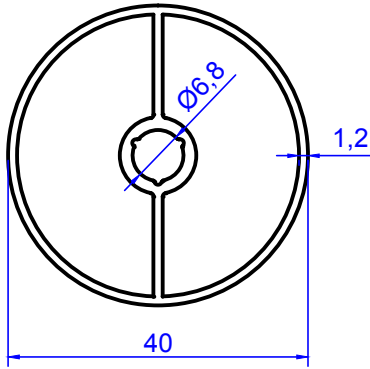

2242
0.604 kg/m

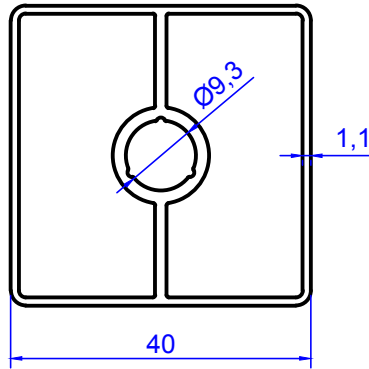

2243
0.721 kg/m

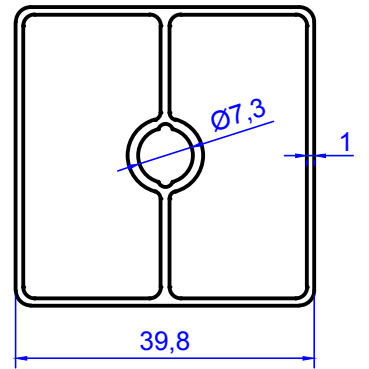

2244
0.610 kg/m

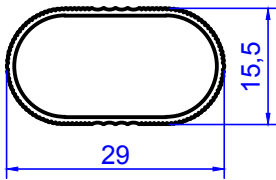

2245
0.179 kg/m

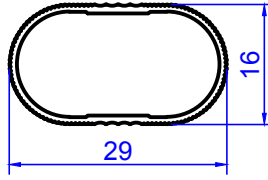

2246
0.190 kg/m

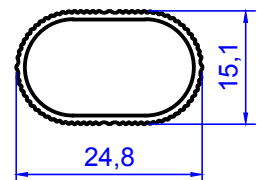

2247
0.176 kg/m

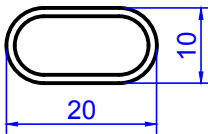

2248
0.144 kg/m

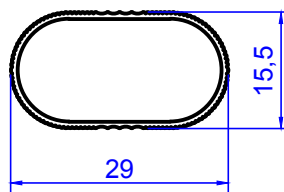

2249
0.160 kg/m

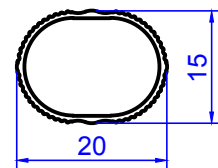

2250
0.119 kg/m

MOBILYA KATALOG ASKI VE MASA AYAK PROFILLERİ

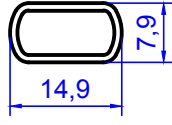

2251
0.100 kg/m

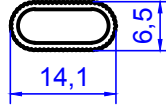

2252
0.081 kg/m

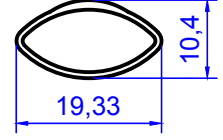

2253
0.103 kg/m

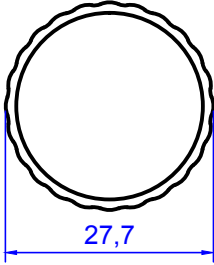

2254
0.282 kg/m

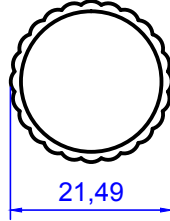

2255
0.214 kg/m

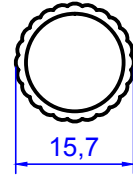

2256
0.152 kg/m

MOBILYA KATALOG KULP PROFİLLERİ

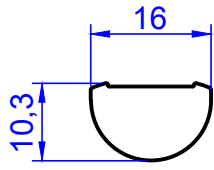

2257
0.355 kg/m

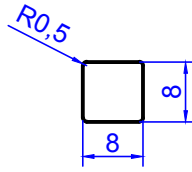

2258
0.173 kg/m

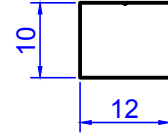

2259
0.325 kg/m

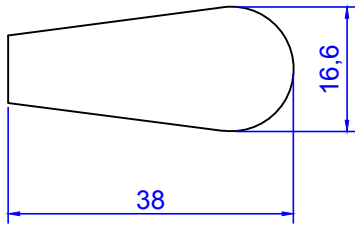

2260
1.295 kg/m

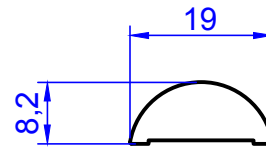

2261
0.303 kg/m

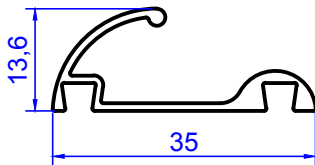

2262
0.225 kg/m

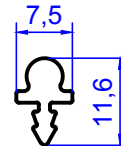

2263
0.111 kg/m

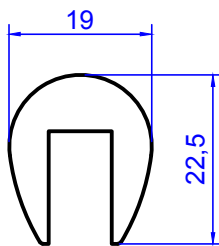

2264
0.605 kg/m

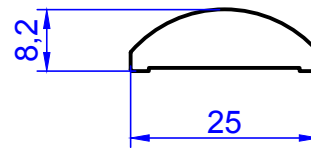

2265
0.413 kg/m

MOBILYA PROFİLLERİ KULP PROFİLLERİ

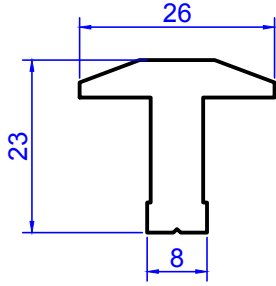

2266
0.640 kg/m

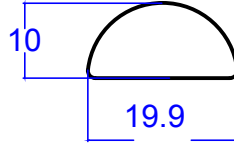

2267
0.425 kg/m

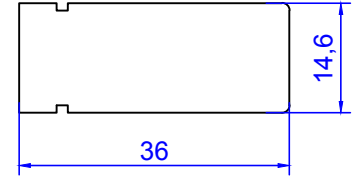

2268
1.412 kg/m

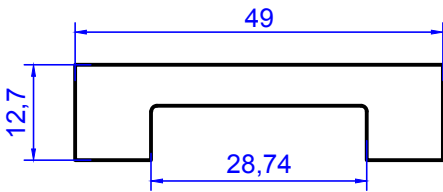

2269
0.401 kg/m

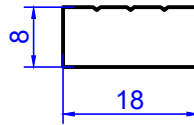

2270
0.388 kg/m

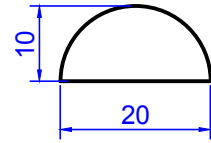

2271
0.425 kg/m

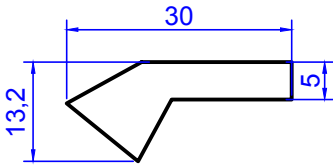

2272
0.493 kg/m

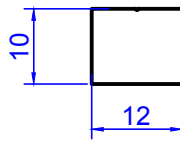

2273
0.325 kg/m

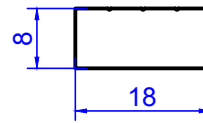

2274
0.390 kg/m

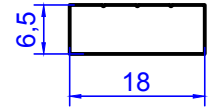

2275
0.317 kg/m

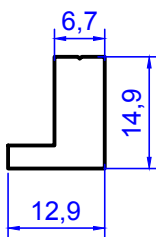

2276
0.322 kg/m

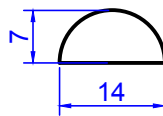

2277
0.209 kg/m

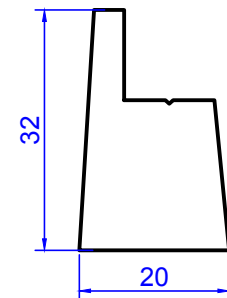

2278
1.138 kg/m

MOBILYA PROFİLLERİ KULP PROFİLLERİ

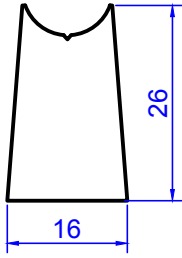

2279
0.897 kg/m

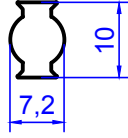

2280
0.146 kg/m

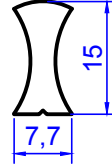

2281
0.192 kg/m

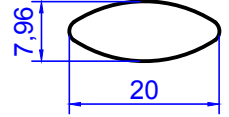

2282
0.320 kg/m

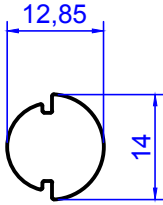

2283
0.344 kg/m

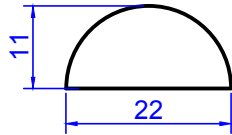

2284
0.515 kg/m

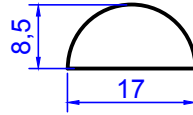

2285
0.306 kg/m

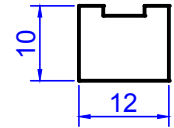

2286
0.303 kg/m

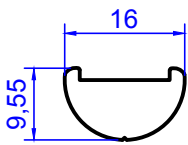

2287
0.287 kg/m

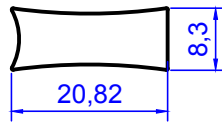

2288
0.401 kg/m

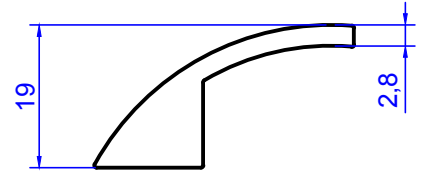

2289
0.509 kg/m

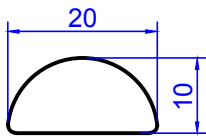

2290
0.425 kg/m

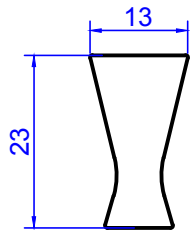

2291
0.542 kg/m

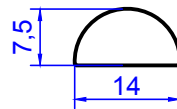

2292
0.228 kg/m

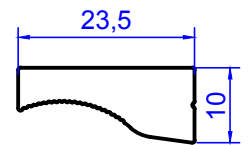

2293
0.431 kg/m

MOBİLYA PROFİLLERİ KULP PROFİLLERİ

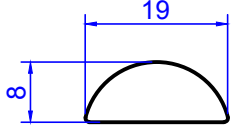

2294
0.317 kg/m

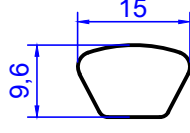

2295
0.312 kg/m

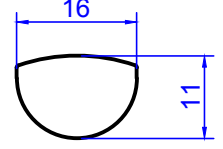

2296
0.382 kg/m

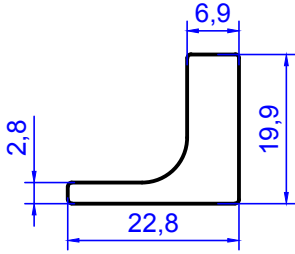

2297
0.513 kg/m

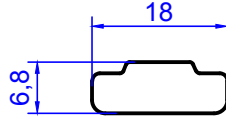

2298
0.292 kg/m

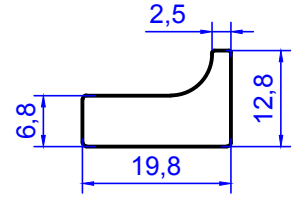

2299
0.422 kg/m

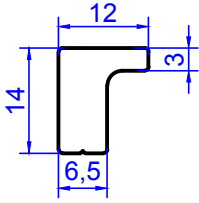

2300
0.293 kg/m

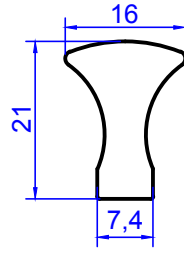

2301
0.477 kg/m

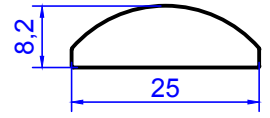

2302
0.463 kg/m

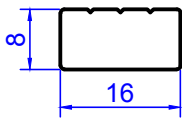

2303
0.344 kg/m

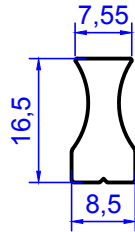

2304
0.279 kg/m

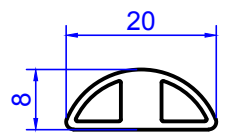

2305
0.215 kg/m